

LED MiniDisc Light

A robust LED marker light ideal for public or residential applications, indoor or outdoor.



DIMMABLE

Now available with Amber LED, that meets FWC requirements



Features

- Now dimmable on the primary power supply side with our new dimmable LED Drivers!
- Long life – 50,000 hours
- Low power consumption of 0.24 watts per fixture
- Safe 12 volt, Class 2 power supply (not included)
- Up to 100 fixtures per power supply
- cETLus listed for in-wall, IC ceiling, in-floor, outdoor wet, and outdoor burial applications
- Fits in any 1" diameter hole, 3 1/2" long
- 2 year limited warranty, 3 years on stainless steel

Applications

- Steps
- Aisles
- Paths
- Driveways
- Direction lighting
- Information lighting
- Decorative lighting
- Merchandising
- Landscape accents

Replacement LED Modules

LCL-LEDMOD-WH

LED Mini Disc Light module, 12V, white LED 5400K

LCL-LEDMOD-WW

LED Mini Disc Light module, 12V, warm white LED 2900K

Installation Wire

LW-18G-BUR

For outdoor burial connections

LW-18G-CL2

For indoor through wall connections

NOTE: One of the above wires MUST be used in order to maintain product warranty.

Specifications

Electrical	12V DC, 20mA, 0.24W
Wiring Options	Each LED Driver can power up to 200 LED MiniDisc Lights by parallel wiring ("daisy chain") between fixtures. NOTE: Use LW-18G-CL2 for all in-wall applications. Use LW-18G-BUR for all burial applications.
LED Life	50,000 hours
LED Colours	White 5400K, Warm White 2900K, Blue, Green, Amber, Red
Construction	Both cover and barrel are die cast aluminum or stainless steel for corrosion protection, strength, weight and consistency of finish.
Cover Finish	Aluminum, White, Bronze, Black, Stainless Steel
Barrel Finish	Aluminum, White, Bronze, Black, Stainless Steel
Lens	Frosted Tempered Glass
Approvals	cETLus listed and labeled for wet, IC, ceiling, wall and direct burial applications.

Product Codes

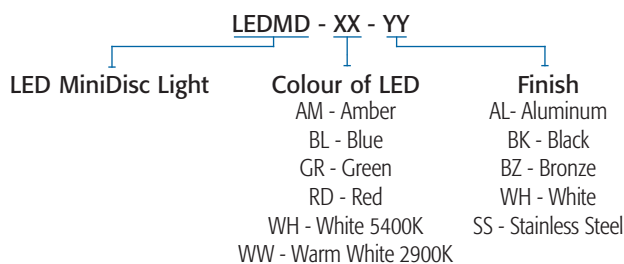

Product Codes (Square)

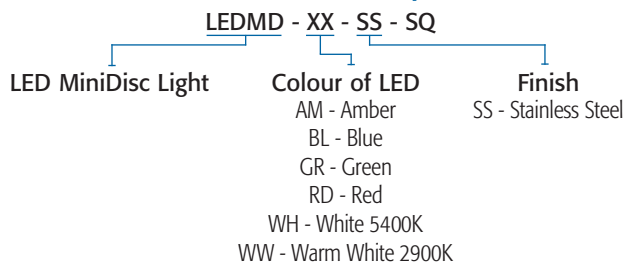

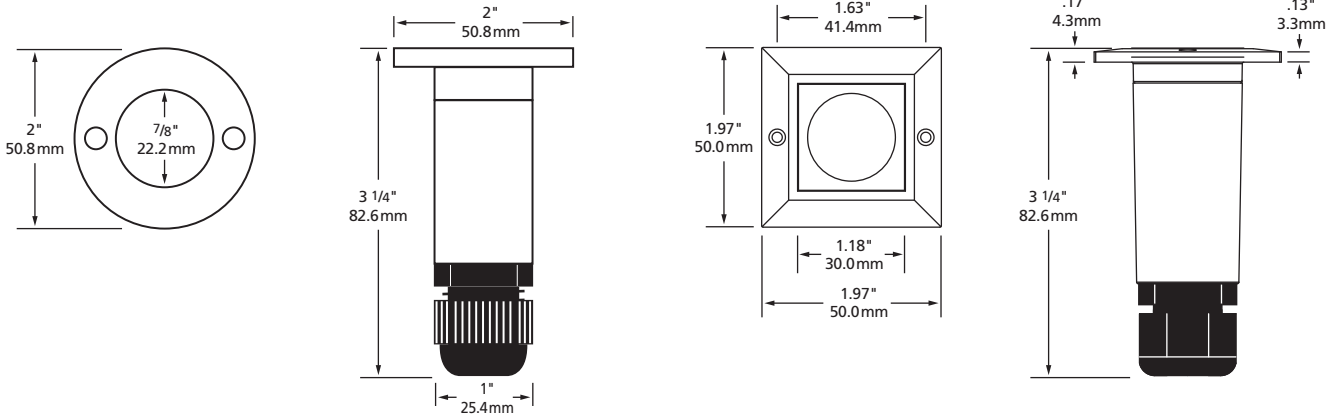

Accessories



LEDMD-CF
LED MiniDisc Light concrete form for concrete pour applications. Fits over most 1/2" (12.7mm) conduit junction boxes.

LEDMD-CF-SQ
LED MiniDisc Light Square concrete form for concrete pour applications. Fits over most 1/2" (12.7mm) conduit junction boxes.

100% LED Light Output Chart

With every foot of lead wire and every light fixture, there is voltage loss. With too much voltage loss all light fixtures will not develop 100% of their potential output. Below is a chart of acceptable voltage loss which will maintain 100% of the potential light output of the LED MiniDisc Light. Simply plot the number of LED MiniDiscs you wish to place on one lead on the horizontal axis, with the total distance from the LED Driver to the last LED MiniDisc on the vertical axis. If the resulting plot is at or below the line shown, you will have acceptable voltage loss and your LED MiniDisc will output 100% of their potential.

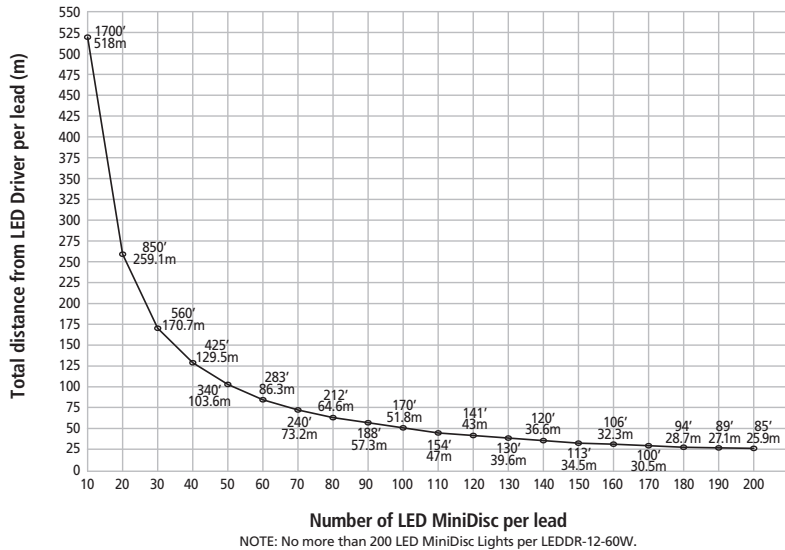

Indoor/Outdoor Dimmable Drivers

MLDRE-20-12-DM
20 Watts
Max. recommended load 18 W or 75 LED MiniDisc Lights
Min. recommended load 8 W or 34 LED MiniDisc Lights
6.77" x 2.67" x 1.26" (171 x 68 x 32mm)

MLDRE-60-12-DM
60 Watts
Max. recommended load 54 W or 200 LED MiniDisc Lights
Min. recommended load 8 W or 34 LED MiniDisc Lights
6.77" x 2.67" x 1.26" (171 x 68 x 32mm)

NOTE: For outdoor installations, please add E-KO-SR strain relief.

Non Dimmable Drivers

LEDDR-12-20W-HW
Indoor driver
20W hardwire
Input: 100 - 240V AC
Output: 12V DC
Max. 75 MiniDisc Lights
4 1/8" x 4 1/8" x 1 1/2" (104.8 x 104.8 x 38.1mm)

LEDDR-12-60W
Indoor/Outdoor driver
60W hardwire
Input: 100 - 240V AC
Output: 12V DC
Max. 200 MiniDisc Lights
9 11/16" x 2 9/16" x 2 1/16" (246 x 65 x 52mm)

LED MiniDisc Light (Scoop)

LED MiniDisc Scoop is designed to direct light where you want it. Ideal for stair lighting when placed on risers to avoid glare. Great for theatre aisle ways.



DIMMABLE

Now available with Amber LED, that meets FWC requirements



Features

- Now dimmable on the primary power supply side with our new dimmable LED Drivers!
- Long life – 50,000 hours
- Low power consumption of 0.24 watts per fixture
- Safe 12 volt, Class 2 power supply (not included)
- Up to 100 fixtures per power supply
- cETLus listed for in-wall, IC ceiling, in-floor, outdoor wet, and outdoor burial applications
- Fits in any 1" diameter hole, 3 1/2" long
- 2 year limited warranty, 3 years on stainless steel

Applications

- Steps
- Aisles
- Paths
- Driveways
- Direction lighting
- Information lighting
- Decorative lighting
- Merchandising
- Landscape accents

Specifications

Electrical	12V DC, 20mA, 0.24W
Wiring Options	Each LED Driver can power up to 200 LED MiniDisc Lights by parallel wiring ("daisy chain") between fixtures. NOTE: Use LW-18G-CL2 for all in-wall applications. Use LW-18G-BUR for all burial applications.
LED Life	50,000 hours
LED Colours	White 5400K, Warm White 2900K, Blue, Green, Amber, Red
Construction	Both cover and barrel are die cast aluminum or stainless steel for corrosion protection, strength, weight and consistency of finish.
Cover Finish	Aluminum, White, Bronze, Black
Barrel Finish	Aluminum, White, Bronze, Black
Lens	Frosted Tempered Glass
Approvals	cETLus listed and labeled for wet, IC, ceiling, wall and direct burial applications.

Product Codes

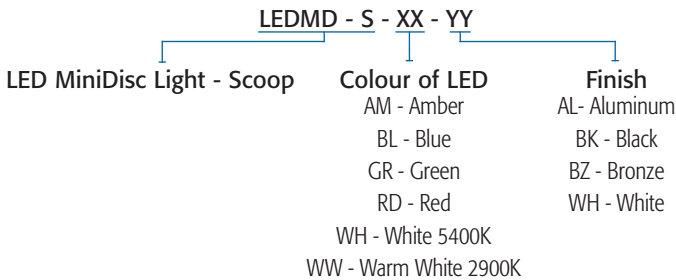

Replacement LED Modules

LCL-LEDMOD-WH

LED Mini Disc Light module, 12V, white LED 5400K

LCL-LEDMOD-WW

LED Mini Disc Light module, 12V, warm white LED 2900K

Installation Wire

LW-18G-BUR

For outdoor burial connections

LW-18G-CL2

For indoor through wall connections

NOTE: One of the above wires MUST be used in order to maintain product warranty.

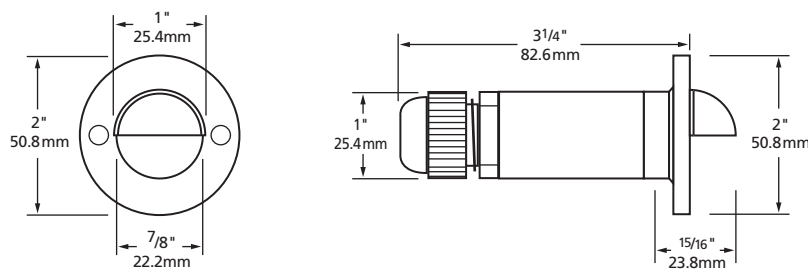

Accessories



LEDMD-CF
LED MiniDisc Light concrete form for concrete pour applications. Fits over most 1/2" (12.7mm) conduit junction boxes.

100% LED Light Output Chart

With every foot of lead wire and every light fixture, there is voltage loss. With too much voltage loss all light fixtures will not develop 100% of their potential output. Below is a chart of acceptable voltage loss which will maintain 100% of the potential light output of the LED MiniDisc Light. Simply plot the number of LED MiniDiscs you wish to place on one lead on the horizontal axis, with the total distance from the LED Driver to the last LED MiniDisc on the vertical axis. If the resulting plot is at or below the line shown, you will have acceptable voltage loss and your LED MiniDisc will output 100% of their potential.

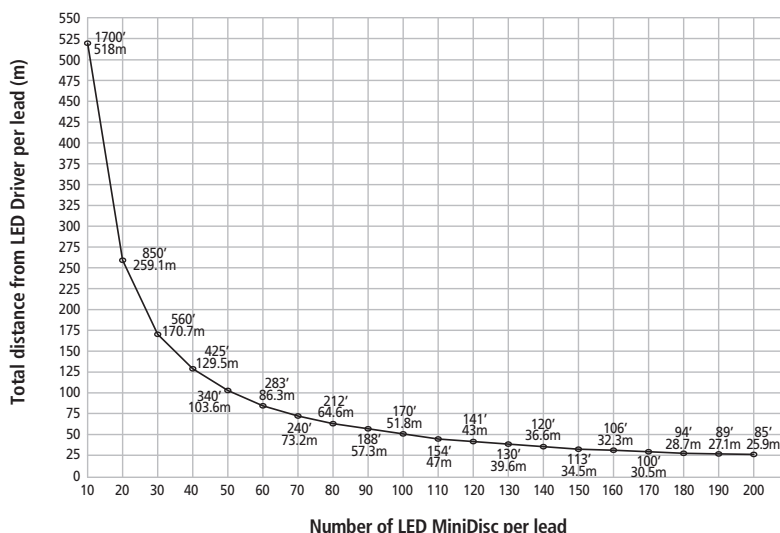

NOTE: No more than 200 LED MiniDisc Lights per LEDDR-12-60W.

Indoor/Outdoor Dimmable Drivers

MLDRE-20-12-DM

20 Watts

Max. recommended load 18 W or 75 LED MiniDisc Lights

Min. recommended load 8 W or 34 LED MiniDisc Lights

6.77" x 2.67" x 1.26" (171 x 68 x 32mm)

MLDRE-60-12-DM

60 Watts

Max. recommended load 54 W or 200 LED MiniDisc Lights

Min. recommended load 8 W or 34 LED MiniDisc Lights

6.77" x 2.67" x 1.26" (171 x 68 x 32mm)

NOTE: For outdoor installations, please add E-KO-SR strain relief.

Non Dimmable Drivers

LEDDR-12-20W-HW

Indoor driver

20W hardwire

Input: 100 – 240V AC

Output: 12V DC

Max. 75 MiniDisc Lights

4 1/8" x 4 1/8" x 1 1/2" (104.8 x 104.8 x 38.1mm)

LEDDR-12-60W

Indoor/Outdoor driver

60W hardwire

Input: 100 - 240V AC

Output: 12V DC

Max. 200 MiniDisc Lights

9 11/16" x 2 9/16" x 2 1/16" (246 x 65 x 52mm)